

• Gehäuse

• Enclosures • Boîtiers

Größe • Size • Grandeur
0

14

- Werkstoff • Material • Matière : St. 1203 • Oberteil: Bl. 0,88 • Boden: Bl. 1,25
- Oberfläche • Surface • Surface : Kunststoffbeschichtet RAL 7032

Art.Nr.: 141 800 00

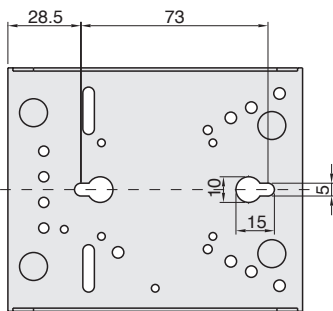
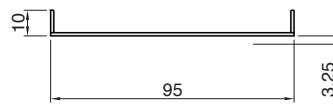
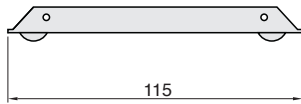
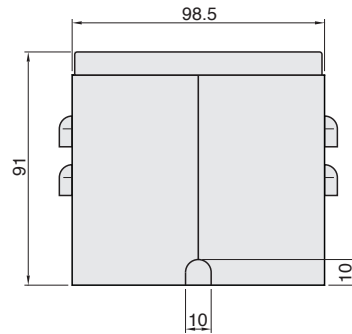
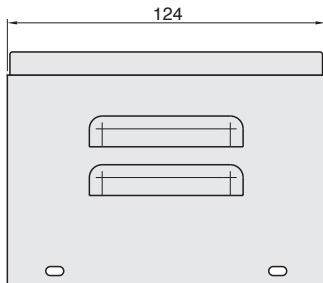

Detaillierte Bemaßung
auf Anfrage



Gehäuse für
Kabelzuführung

Art.Nr.: 141 810 00

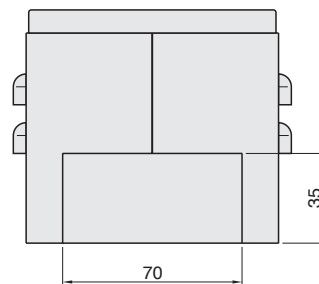
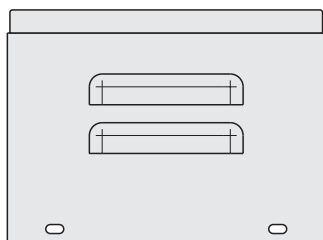

Fehlende Maße siehe
oben

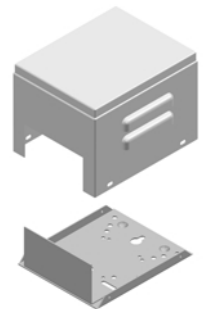
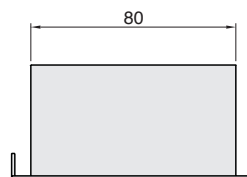
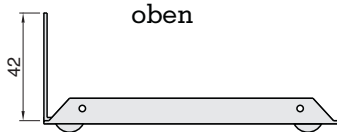

Gehäuse mit
Winkel für
Kabelverschraubung

• Gehäuse

• Enclosures • Boîtiers

Größe • Size • Grandeur
1

14

- Werkstoff • Material • Matière : St. 1203 • Oberteil: Bl. 0,88 • Boden: Bl. 1,25
- Oberfläche • Surface • Surface : Kunststoffbeschichtet RAL 7032

Art.Nr.: 141 801 00

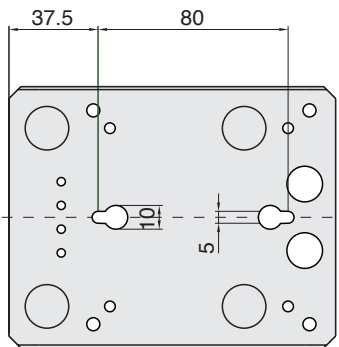
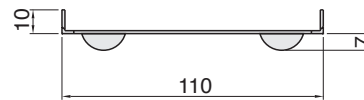
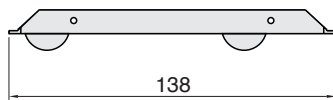
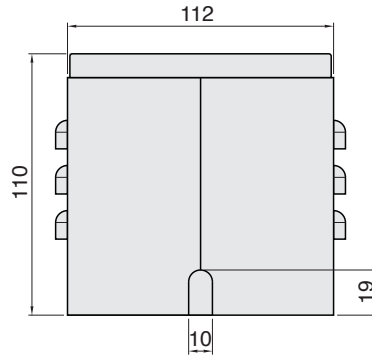
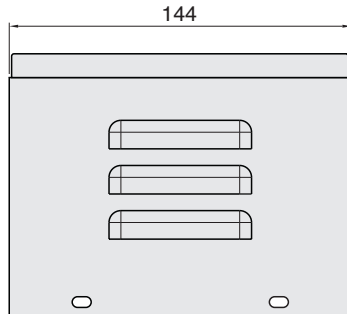

Detaillierte Bemaßung
auf Anfrage

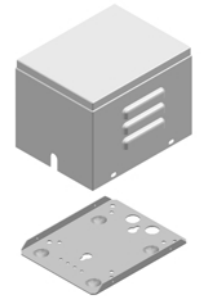

Gehäuse für
Kabelzuführung

Gehäuse auch mit
Griff lieferbar

Art.Nr.: 141 811 00

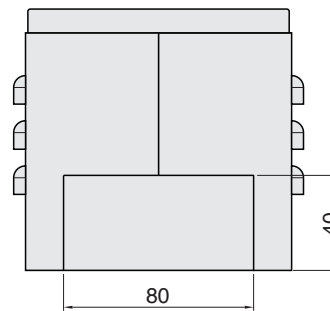
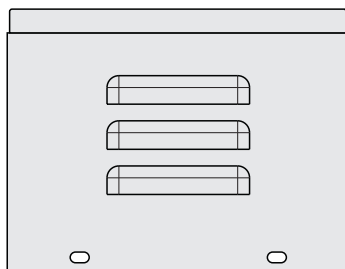

Fehlende Maße siehe
oben

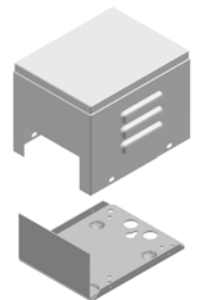
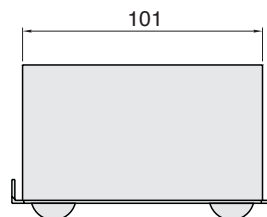

Gehäuse mit
Winkel für
Kabelverschraubung

• Gehäuse

• Enclosures • Boîtiers

Größe • Size • Grandeur
2 + 3

- Werkstoff • Material • Matière : St. 1203 • Oberteil: Bl. 0,88 • Boden: Bl. 1,5
- Oberfläche • Surface • Surface : Kunststoffbeschichtet RAL 7032

Größe 2 • Art.Nr.: 141 802 00
Größe 3 • Art.Nr.: 141 803 00

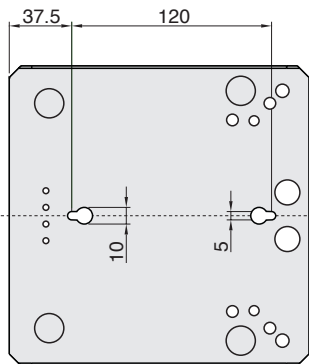
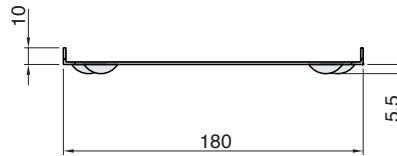
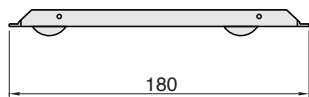
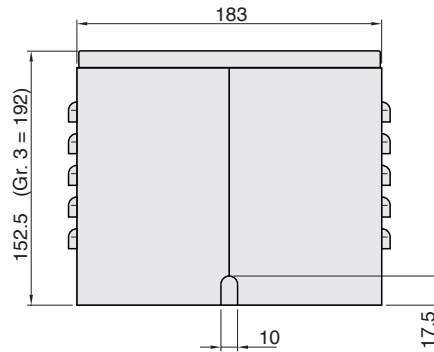
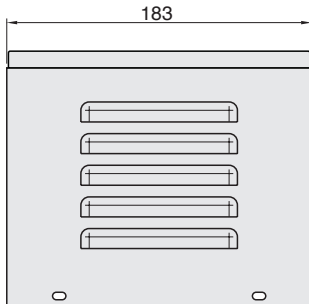

Detaillierte Bemaßung
auf Anfrage

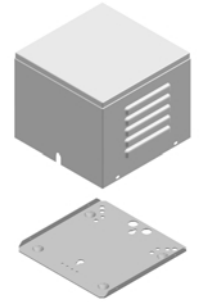

Gehäuse für
Kabelzuführung

Gehäuse auch mit
Griff lieferbar

Größe 2 • Art.Nr.: 141 812 00
Größe 3 • Art.Nr.: 141 813 00

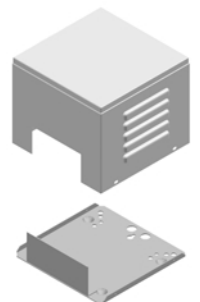
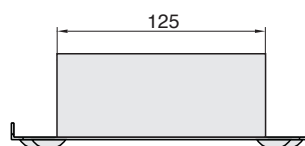
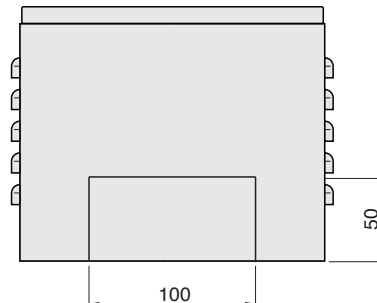
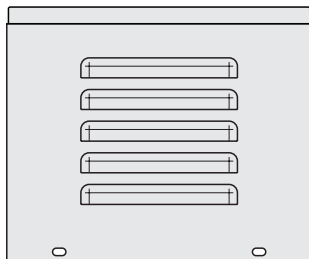

Gehäuse mit
Winkel für
Kabelverschraubung

• Gehäuse

• Enclosures • Boîtiers

Größe • Size • Grandeur
4

14

- Werkstoff • Material • Matière : St. 1203 • Oberteil: Bl. 0,88 • Boden: Bl. 2,0
- Oberfläche • Surface • Surface : Kunststoffbeschichtet RAL 7032

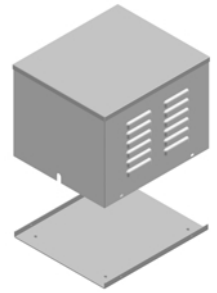
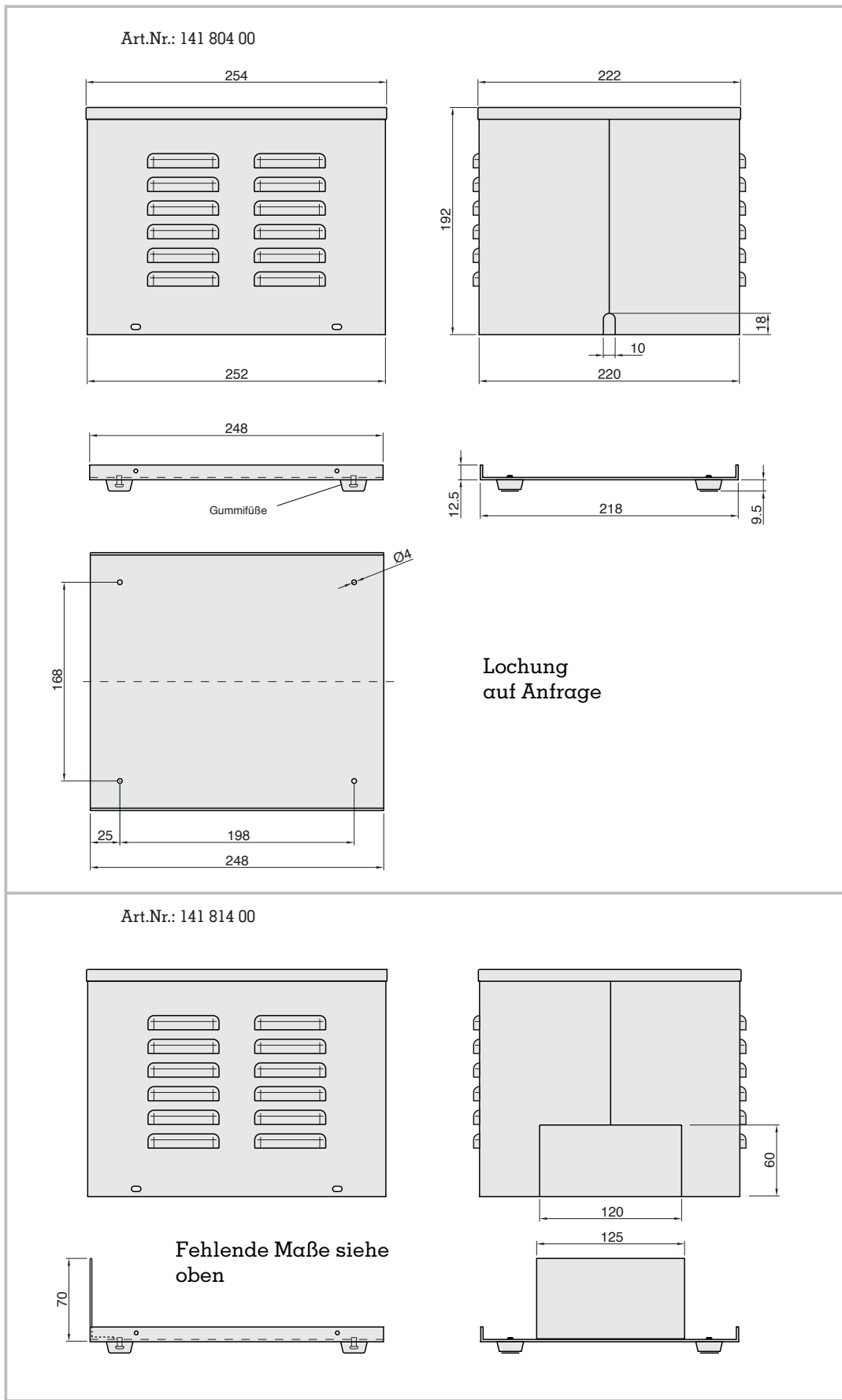

Gehäuse für
Kabelzuführung

Gehäuse auch mit
Griff lieferbar

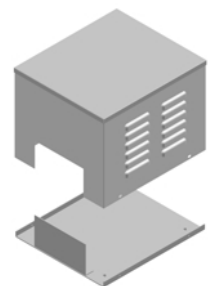

Gehäuse mit
Winkel für
Kabelverschraubung

• Gehäuse

• Enclosures • Boîtiers

Größe • Size • Grandeur
4a

14

- Werkstoff • Material • Matière : St. 1203 • Oberteil: Bl. 0,88 • Boden: Bl. 2,0
- Oberfläche • Surface • Surface : Kunststoffbeschichtet RAL 7032

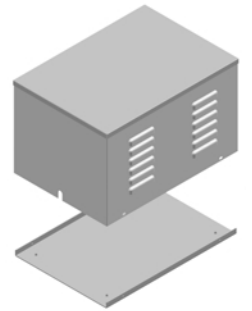
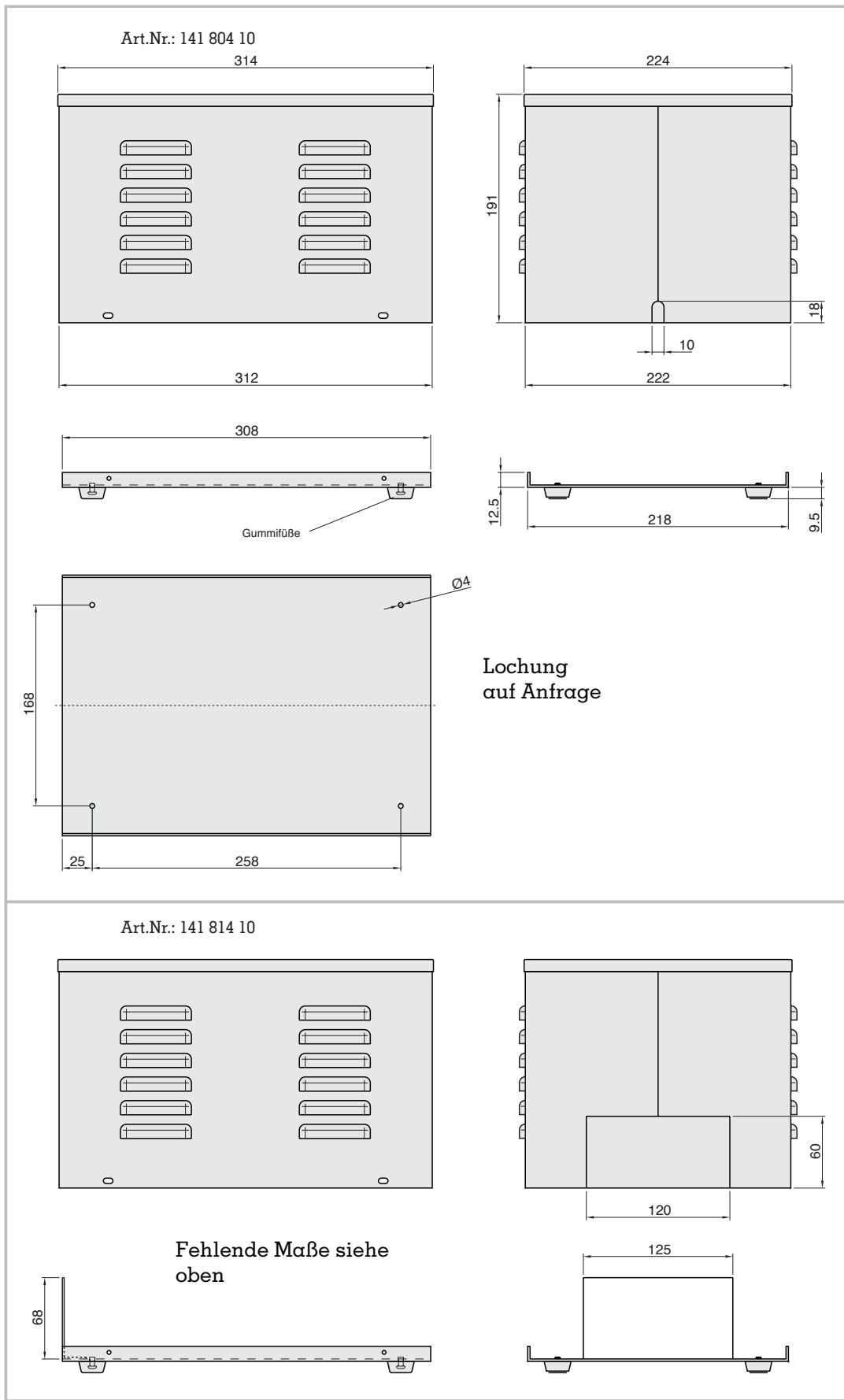

Gehäuse für
Kabelzuführung

Gehäuse auch mit
Griff lieferbar

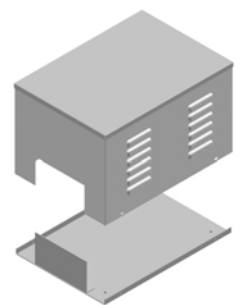

Gehäuse mit
Winkel für
Kabelverschraubung